



**ITU-BDT Regional Workshop on Guidelines
on the Smooth transition of Existing Mobile
Networks to IMT-2000 for the Arab Region**

"Mobile Network Evolution to NGN"



Damascus, Syria
13-15/06/2005
Roland THIES

 ARCHITECTS OF AN INTERNET WORLD 

Presentation Outline

What is NGN and how it applies in Mobile Networks?

- > Mobile Networks Architectures
- > Why NGN?

 - Mobile Network Evolution to NGN — 2 All rights reserved © 2005, Alcatel 

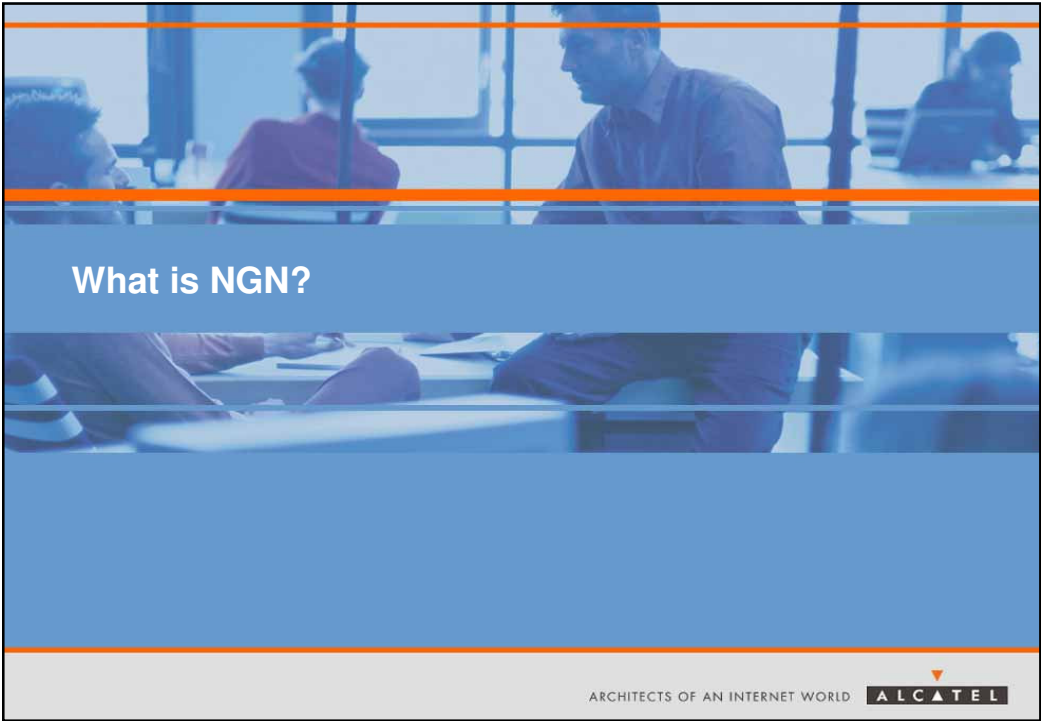

What is NGN?

ARCHITECTS OF AN INTERNET WORLD 

What is NGN?

NGN: Next Generation Networks

- ☒ Separation of
 - ☒ Access Layer
 - ☒ Transport Layer
 - ☒ Control Layer
 - ☒ Service Layer
- ☒ with Control & Transport Layers being shared by
 - ☒ the different Access Type (RAN, Fixed...)
 - ☒ and Service Layers
- ☒ with Packet (ATM, IP) Transport converging toward IP transport
- ☒ for provision of **Multimedia Services** (Real Time, Presence, Messaging, Voice, Video, Data...)



Mobile Network Evolution to NGN — 4

All rights reserved © 2005, Alcatel



What is NGN?

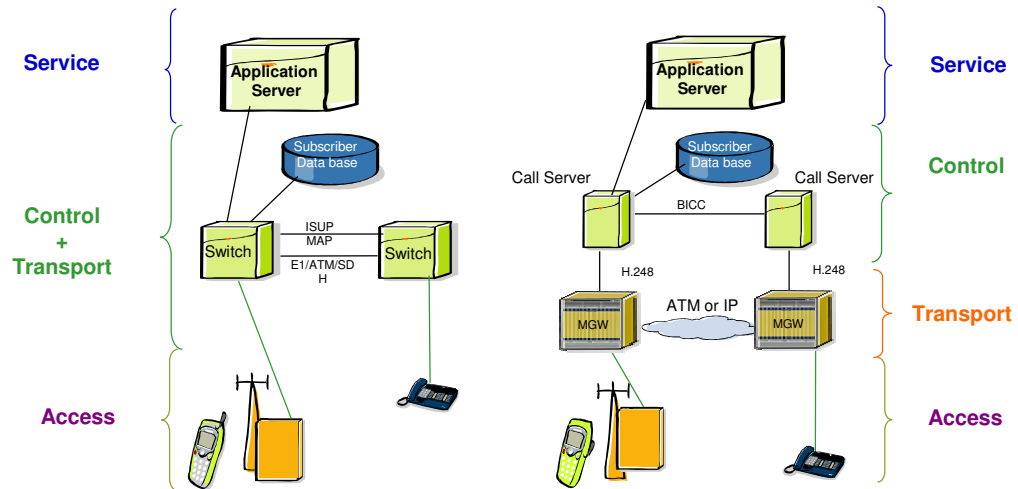

- Mobile Network Evolution to NGN — 5

All rights reserved © 2005, Alcatel



How NGN applies in Mobile Networks?

ARCHITECTS OF AN INTERNET WORLD



How NGN Applies in Mobile Networks?

- ☒ **UMTS R99:**
 - ☒ Largely derived from GSM
 - ☒ Last non-NGN Release
 - ☒ Features content functionally frozen 12/2000
 - ☒ Still Change Requests
- ☒ **UMTS R4:**
 - ☒ NGN in Cs Domain with Separation of Control and User layers
 - ☒ Introduction of Call Server & MGW
 - ☒ Introduction of ATM and IP transport instead of TDM
 - ☒ Standard completed in March 2001
- ☒ **UMTS R5:**
 - ☒ NGN for IMS
 - ☒ Introduction of MM Call Server with SIP Call Control Protocol
 - ☒ Standard Content frozen in June 2003



GSM Radio Technology Evolution

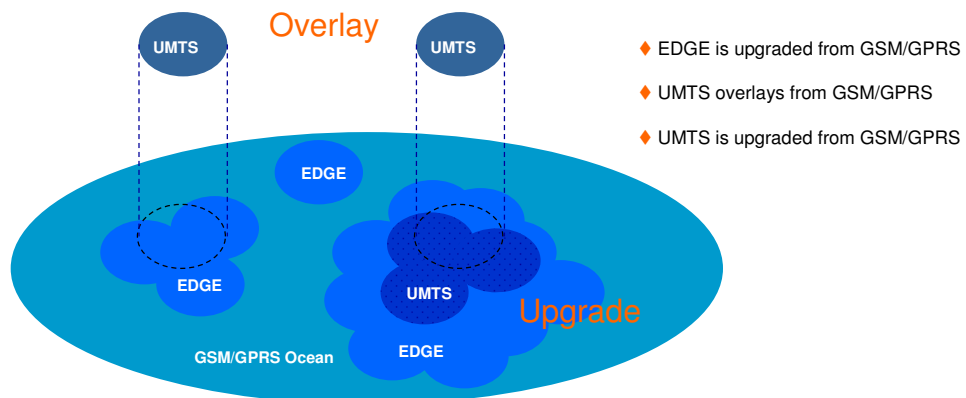

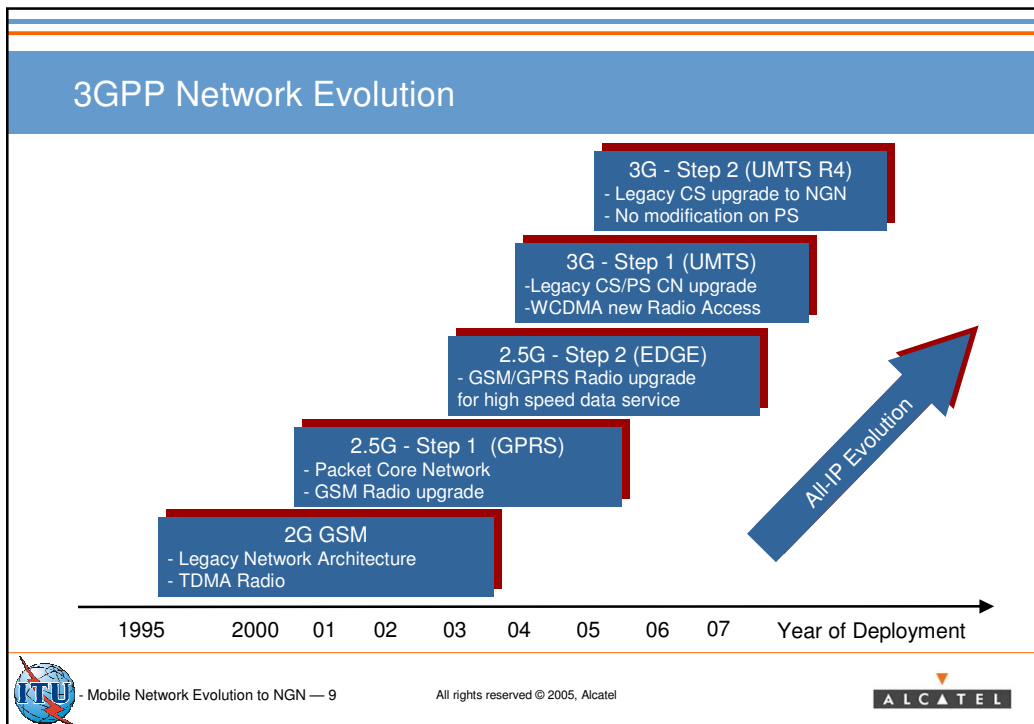

How NGN Applies in Mobile Networks?

- ☒ **CDMA 1x RTT:**
 - ☒ Extended radio technology from IS95
 - ☒ Last non-NGN Release
 - ☒ Release 0 in commercial service since Oct 2000
 - ☒ New overlay Packet Data Serving Node
- ☒ **CDMA 1x EV-DO:**
 - ☒ Hybrid CDMA+TDMA technologies for bursty applications (High Speed Data)
 - ☒ Requires a separate carrier (1.25MHz), mainly deployed for hot zones.
 - ☒ Could be developed independent of IS95/1xRTT. (No MSC/VLR needed)
 - ☒ Commercial service in SK, China, Japan, USA
- ☒ **CDMA 1x EV-DV:**
 - ☒ NGN in Cs Domain with Separation of Control and User layers
 - ☒ Backward compatible with CDMA2000 1xRTT
 - ☒ Field Trials ongoing

ITU - Mobile Network Evolution to NGN — 10 All rights reserved © 2005, Alcatel ALCATEL

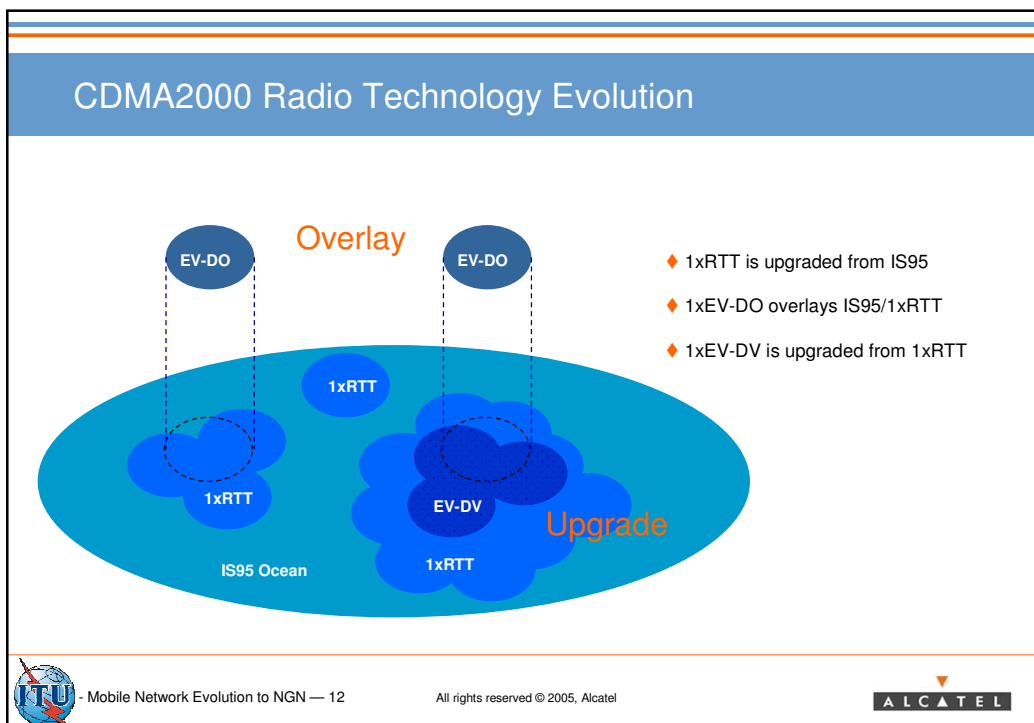
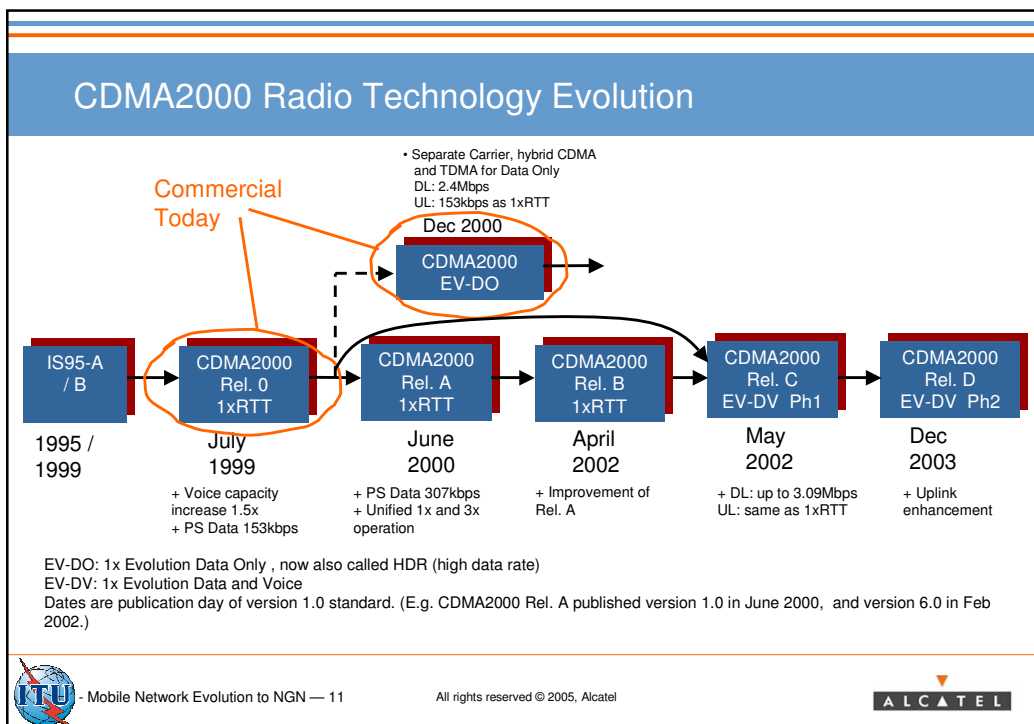

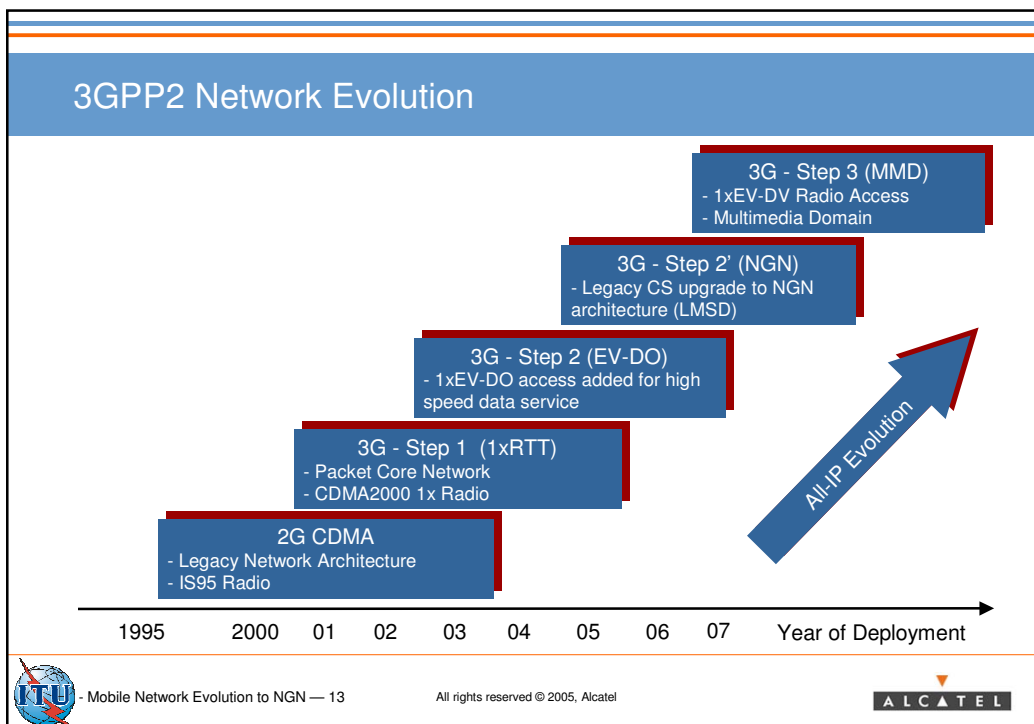

Presentation Outline

- > What is NGN and how it applies in Mobile Networks?
- > **Mobile Networks Architectures**
 - > 2G/3G Mobile Networks
 - > NGN Evolution
- > Why NGN?

- Mobile Network Evolution to NGN — 14 All rights reserved © 2005, Alcatel

GSM Architecture

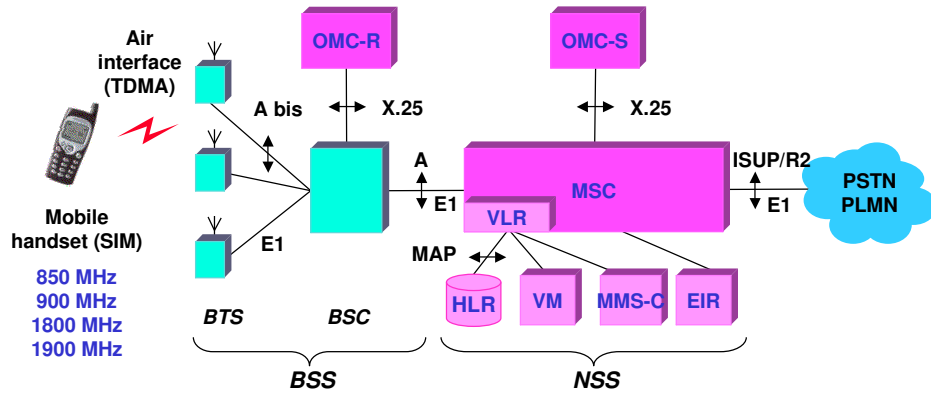

CDMA Architecture

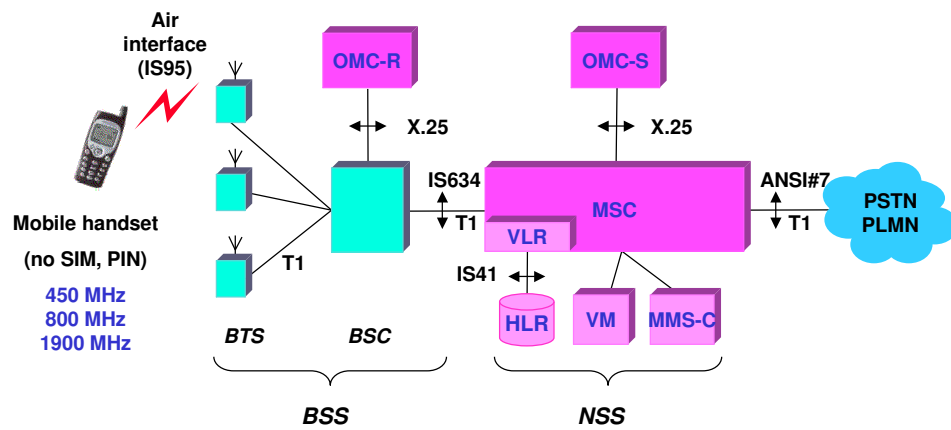

2.5G GPRS/EDGE

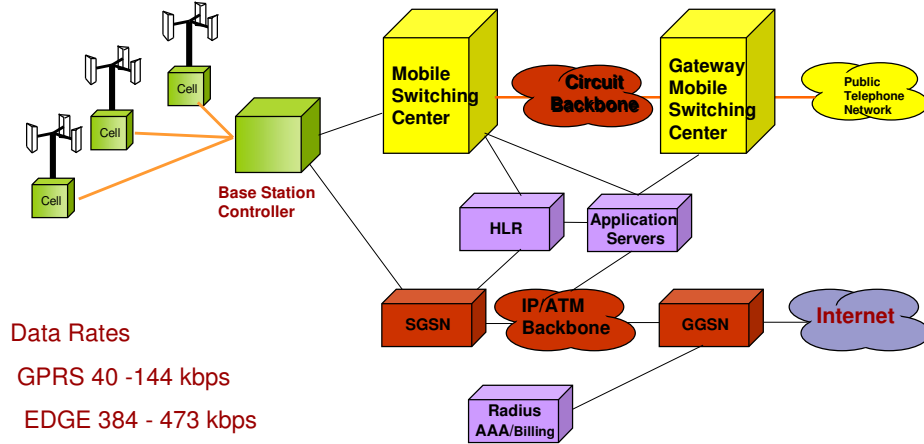

2.5G CDMA 1XRTT

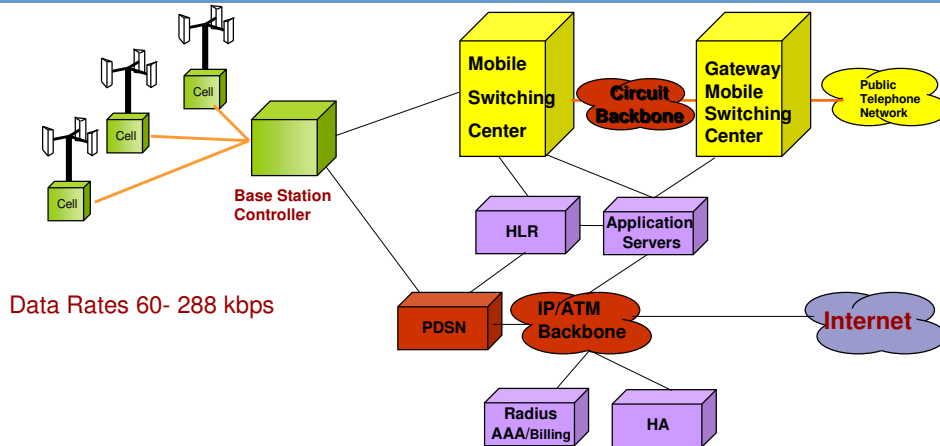

3G W-CDMA R3 (R99)

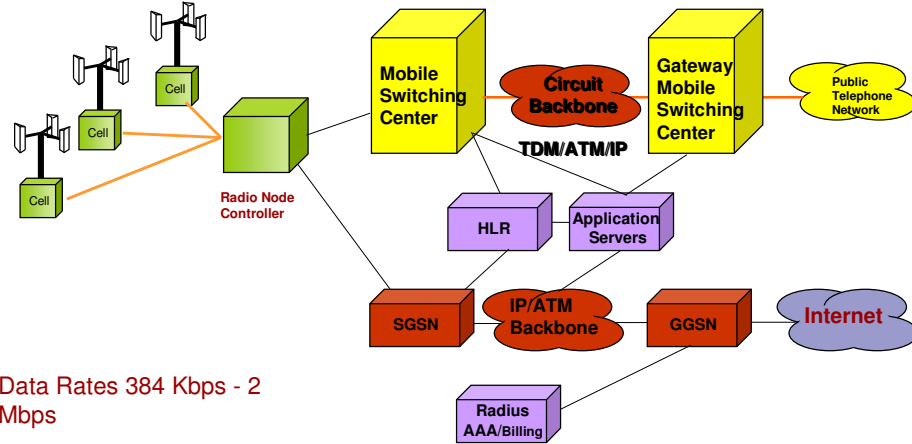

Presentation Outline

- > What is NGN and how it applies in Mobile Networks?
- > **Mobile Networks Architectures**
 - > 2G/3G Mobile Networks
 - > NGN Evolution
- > Why NGN?



3G W-CDMA R4

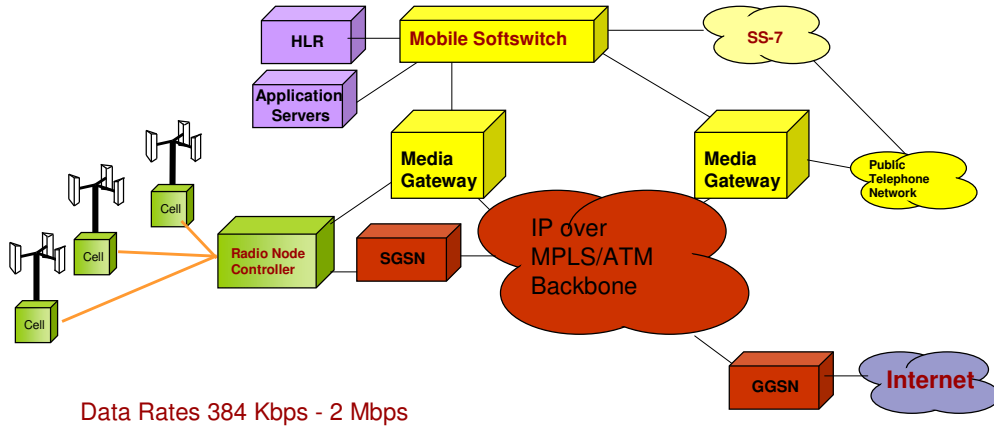

3G W-CDMA R5/R6 (IMS)

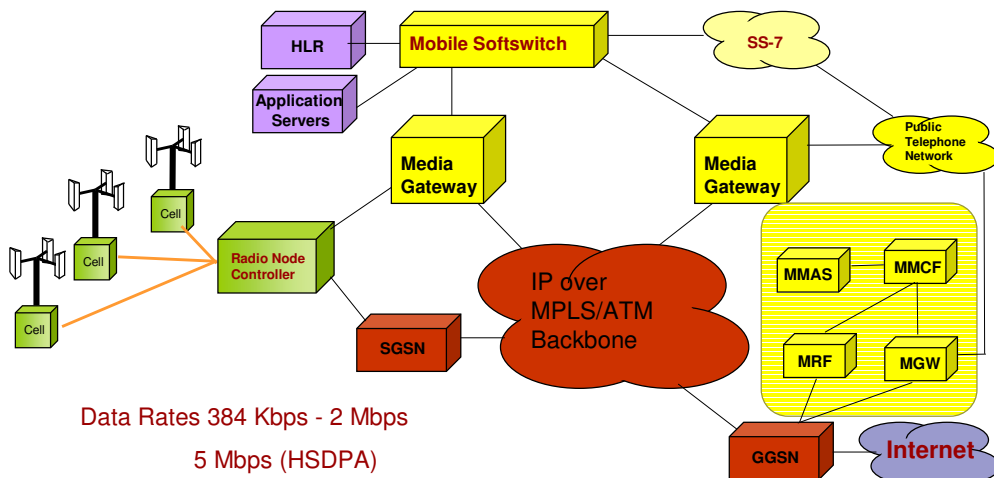

3G CDMA 2000

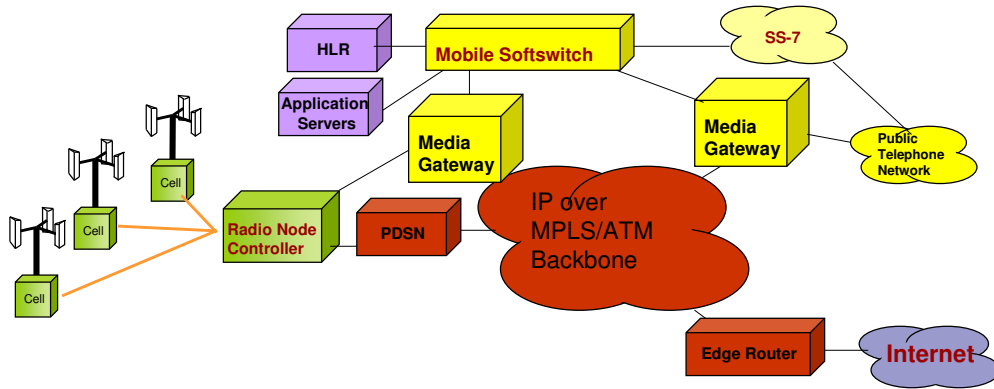

Data Rates 2 - 5 Mbps



IMS: Delivering User-Centric Services

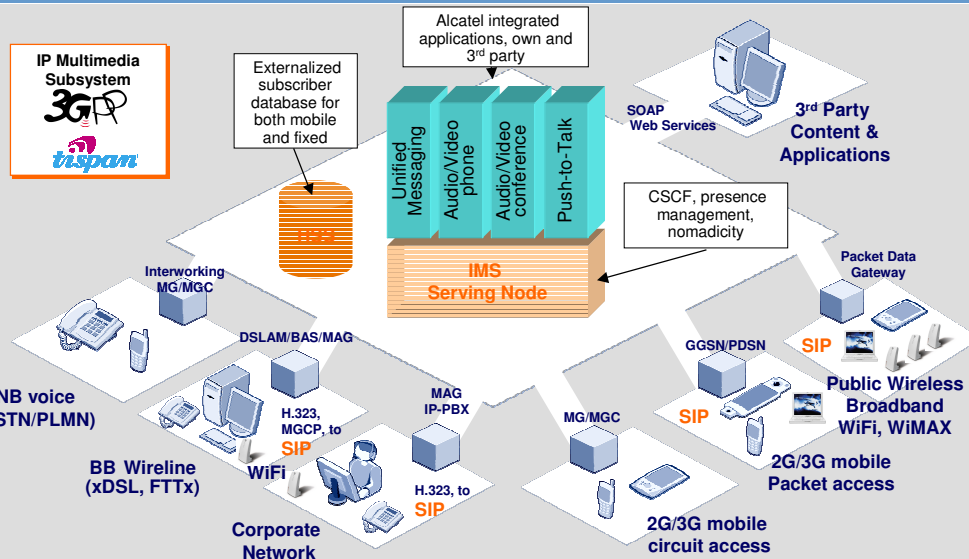

Presentation Outline

- > What is NGN and how it applies in Mobile Networks?
- > Mobile Networks Architectures
- > **Why NGN?**



Why NGN?

- 1 - Transport Network Simplification
- 2 - Higher Network Scalability
- 3 - Bandwidth Saving
- 4 - New Services



Why NGN?

1- Transport Network Simplification - Common Cs/Ps Backbone

- ☒ Only one transport backbone for Voice, Data on ATM or IP
- ☒ improved resources use efficiency
 - ☒ resources sharing
 - ☒ one network management

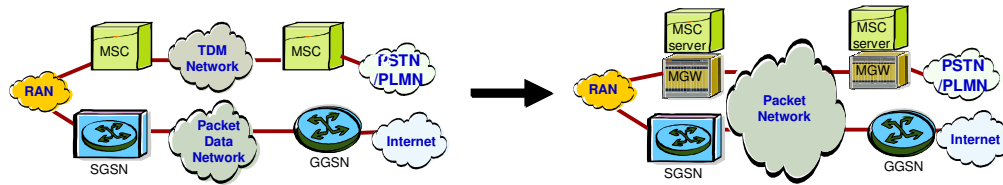

Why NGN?

1- Transport Network Simplification - No Transit Layer

- ☒ No Need for Transit Layer MSC
- ☒ Dynamic connection establishment between nodes
- ☒ in ATM through SVC, in IP through routing

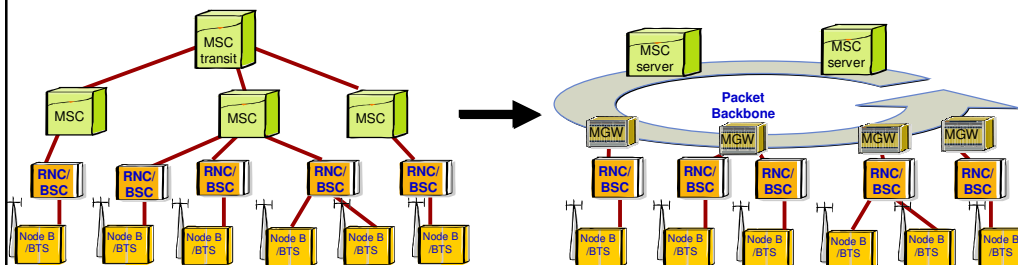

Why NGN?

1- Transport Network Simplification - Common Signalling/Packet Backbone

☒ With Signalling over IP, no Need for Dedicated Signalling Network

- ☒ simplification of transport network
- ☒ improved resource use efficiency

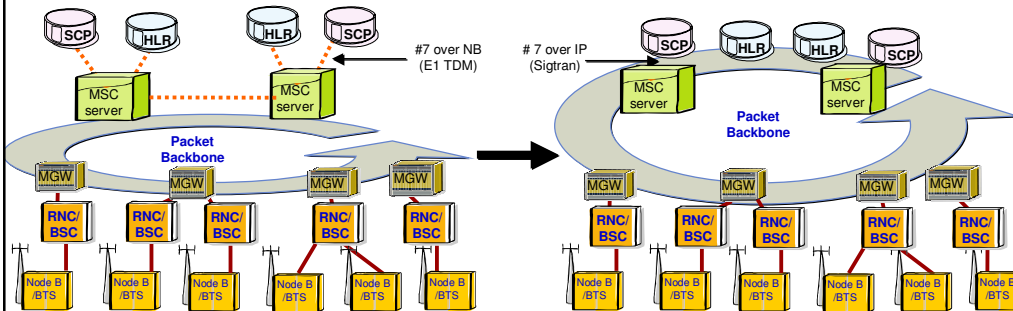

Why NGN?

1- Transport Network Simplification - Common CN/RAN backbone

☒ With IP in RAN in R5, Merge of CN & RAN IP Transport Networks

- ☒ simplification of transport network
- ☒ improved resource use efficiency

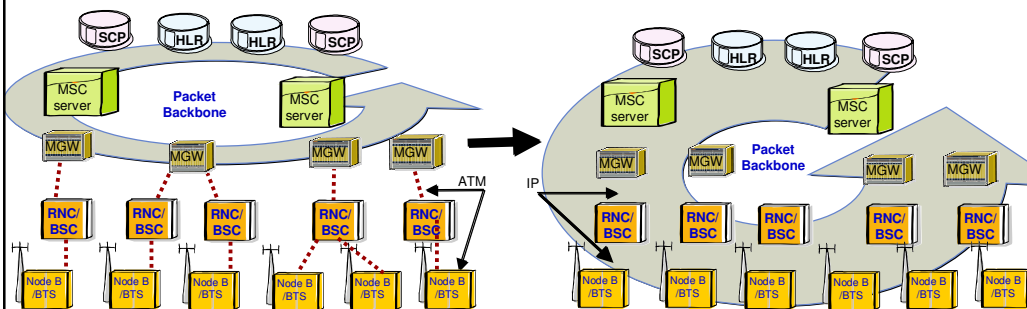

Why NGN?

2- Bandwidth Saving

- ☒ End to End AMR voice transport (3G/3G Call)
- ☒ Bandwidth optimisation
- ☒ Transcoder saving
- ☒ Voice quality improvement

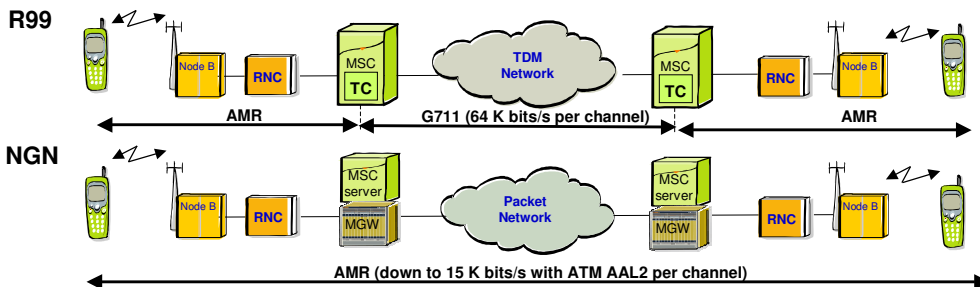

Why NGN?

2- Bandwidth Saving

- ☒ AMR in CN for 3G<->PSTN/2G PLMN Voice Call (R4)
- ☒ Bandwidth optimisation

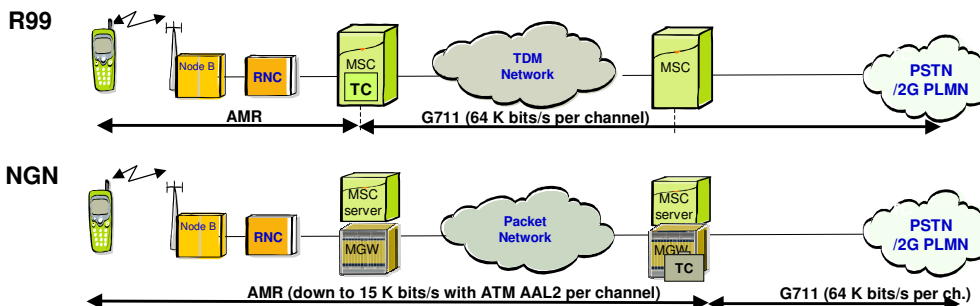

Why NGN? 3- Bandwidth Saving (CS domain)

Transport Bandwidth Efficiency (from R4 & beyond)

transport type kb/s per channel	G711 over TDM (reference)	AMR over ATM AAL2	AMR over POS IP V4	AMR over POS IP V6	AMR over GE IP V4	AMR over GE IP V6	AMR over IP V4 over ATM AAL5	AMR over IP V6 over ATM AAL5	G711 over ATM AAL2
kb/s per voice channel	64	15	34	44	49	59	51	51	85
kb/s per 64kb data ch.	64	85	121	141	151	171	153	204	N/A

- ☒ **ATM AAL2:** the most efficient for both Voice and 64kb/s Data
- ☒ **POS:** the most efficient of the IP transport
- ☒ **64kb/s Data:** Packet transport brings degradation but data traffic on Cs should be low w/r to voice traffic



Why NGN? 3- Bandwidth Saving (PS domain)

Transport type Byte per packet	IP over SDH	IP over ATM AAL5
256 byte IP packet	267	318
512 byte IP packet	525	583

- IP over SDH more efficient than IP over ATM (10 to 20%)



Why NGN?

4- New Services Unified Services through standardized Interfaces

- services independent of access layer type
(fixed, mobile, PC, PDA, Phone)

- one Service Platforms whatever the access layer types
(unlike IN, Voice Mail for Mobile, email for fixed Internet...)

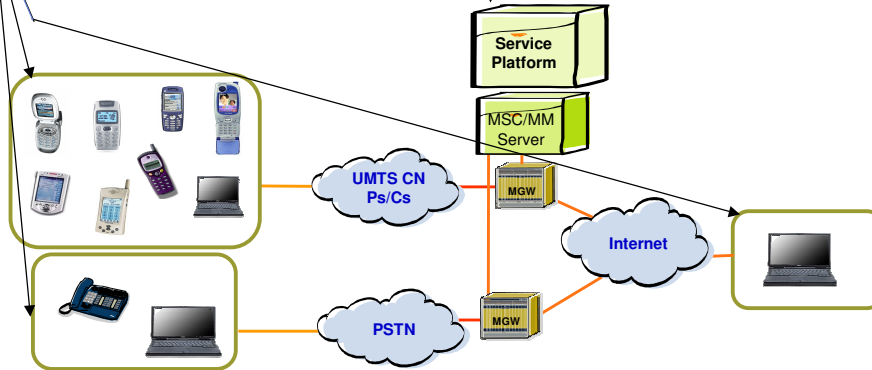

Applications activity overview

- | | |
|--|---|
| <ul style="list-style-type: none"> Push-to-Talk Over Cellular (PTT) PTT to conference Personal Voice Assistant Media Push Movie Renting Web Chat-to-Talk/Conference Push-to-Watch Audio Conferencing Mobile Conferencing Location Based Services Multi-Person Gaming Prepaid Calling Virtual Receptionist | <ul style="list-style-type: none"> IVR, Multi Languages Click-to-Dial/Help/Conference Ringback Tones Toll Saver (Call Back) Email Dial-In & Listen Picture Sharing Ringback Pictures Video Conferencing Voice Activated Dialing IP Contact Center Audio Conferencing with Video Click to services |
|--|---|



Why NGN? 4- New Services

- ☒ **IP as target transport layer with benefit of existing IP services**
- ☒ **Merge and combination of existing services**
 - ☒ **Standardized Video Communication** (between fixed & mobile, video conferencing & video mail)
 - ☒ **Unified messaging** one mail box whatever the message (voice, text, video) & device type
 - ☒ **Multimedia Messaging**
 - ☒ **Instant Messaging**

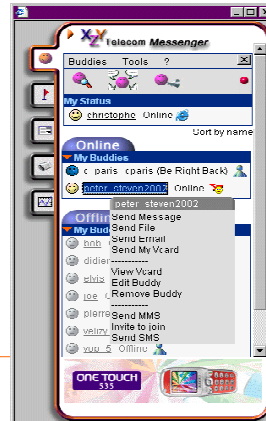

Why NGN?

Summary

CAPEX OPTIMIZER

OPEX OPTIMIZER

REVENUE ASSURANCE

Transport Network Simplification



Higher Network Scalability



Bandwidth Saving



New Services



Conclusion

- > **NGN is the separation between Control and Transport**
- > **NGN is mainly introduced in 3G UMTS R4/R5 and CDMA2000 1x EV-DV**
- > **Only one transport backbone for Voice, Data on ATM or IP**
- > **Bandwidth optimisation, Transcoder saving & Voice quality improvement when Mobile to Mobile/PSTN calls using TrFO**
- > **Unified Services through standardized Interfaces independent of access layer type (fixed, mobile, PC, Phone)**
- > **News Services (Merge and combination of existing services):**
 - ☒ **Standardized Video Communication**
 - ☒ **Unified messaging**
 - ☒ **Multimedia Messaging**
 - ☒ **Instant Messaging**



www.itu.int/ITU-BDT

Thank you for your attention....

